

A battery is a device which can temporarily store and discharge electric energy. The Electric Double Layer Capacitor (EDLC) can replace or supplement batteries due to its outstanding properties, such as low internal resistance & long life. The following introduces application examples, features & benefits of ELNA's EDLC products.

## Contents

*Uses of an Electric Double Layer Capacitor*

Typical application chart for Electric Double Layer Capacitor

Key features and benefits of an Electric Double Layer Capacitor

1. Equalization of input electric power
2. Equalization of output electric power
3. Regeneration of the wasted electric power
4. A reliable power supply in emergency
5. Discharge time required is pre-set

## Typical Electric Double Layer Capacitor Applications & Properties

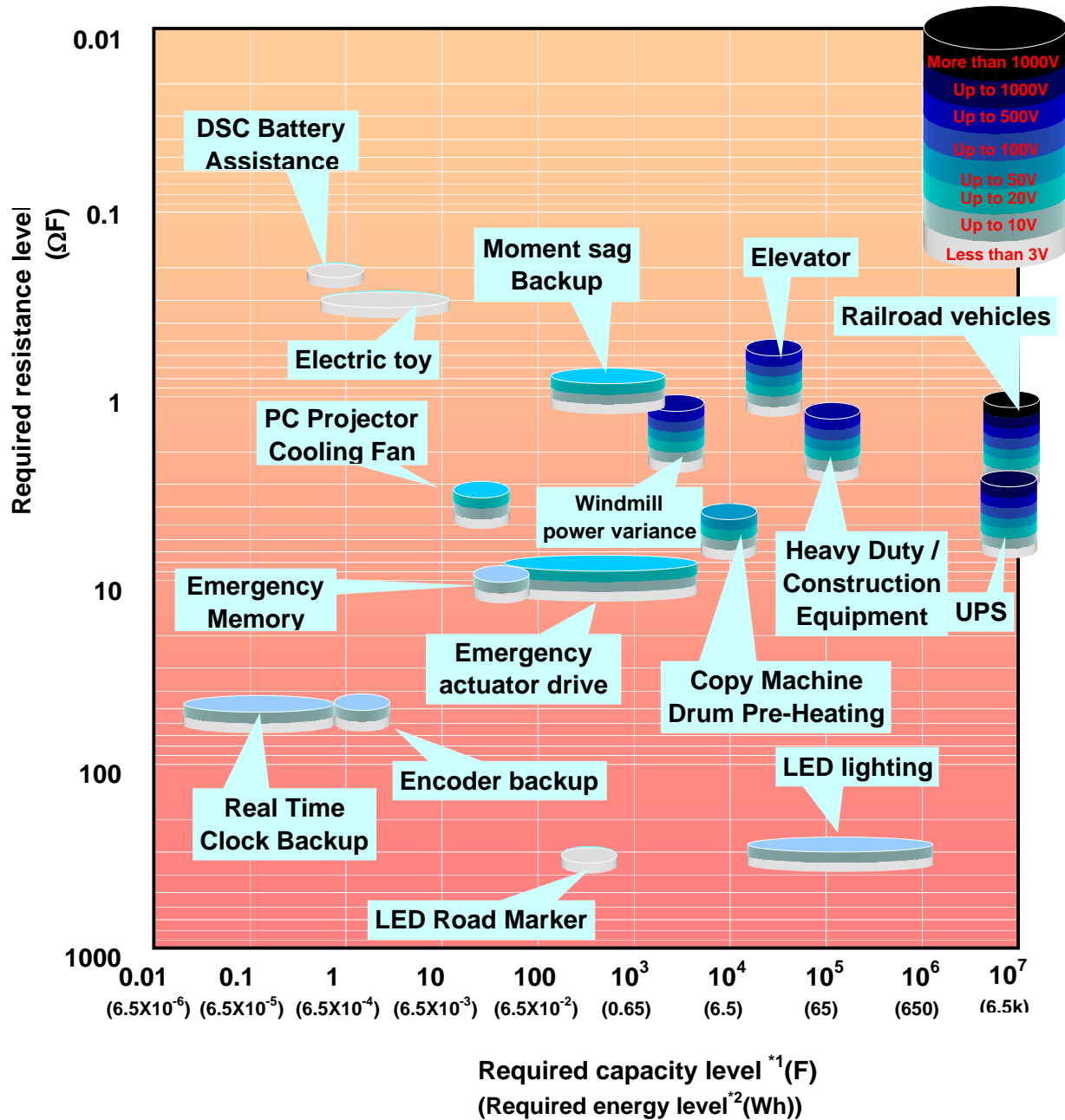

\*1 Capacity converted into 2.5V.

\*2 Electric energy at the time of discharging from 2.5V to 1.25V (50% of charge voltage), per 1 cell.

Chart is typical only and subject to change without notice and may not reflect actual applications

## Features & Benefits of Electric Double Layer Capacitor (compared to battery)

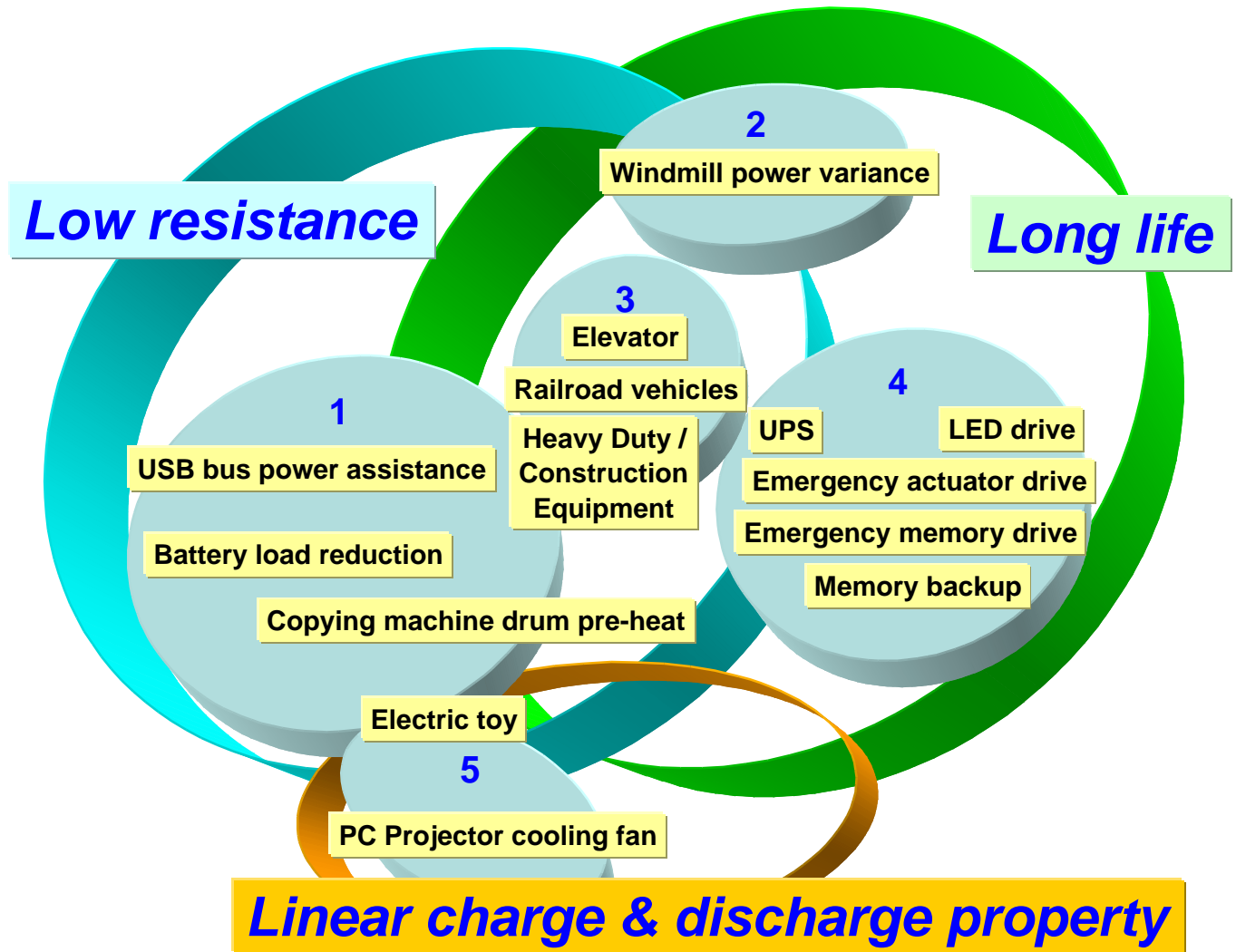

- 1** *Equalization of input electric power.*  
**Benefit:** It charges slowly and discharges quickly.
- 2** *Equalization of output electric power.*  
**Benefit:** It charges quickly and discharges slowly (uniformly).
- 3** *Regeneration of wasted electric power.*  
**Benefit:** It charges quickly and discharges quickly.
- 4** *A reliable power supply for emergencies.*  
**Benefit:** It is maintenance-free and highly reliable.
- 5** *Discharge time required is pre-set.*  
**Benefit:** User interaction is not required.

*It charges slowly and discharges quickly.*

## 1. Equalization of input electric power.

In order to supply a momentary large discharge of power, the Electric Double Layer Capacitor (EDLC) is added to the maximum power supply output (Note: if high power is not needed, a large power supply output will worsen total efficiency). Rapid charge & discharge of the EDLC is possible and with little charge discharge degradation, the EDLC is the the best solution.

### Conceptual diagram

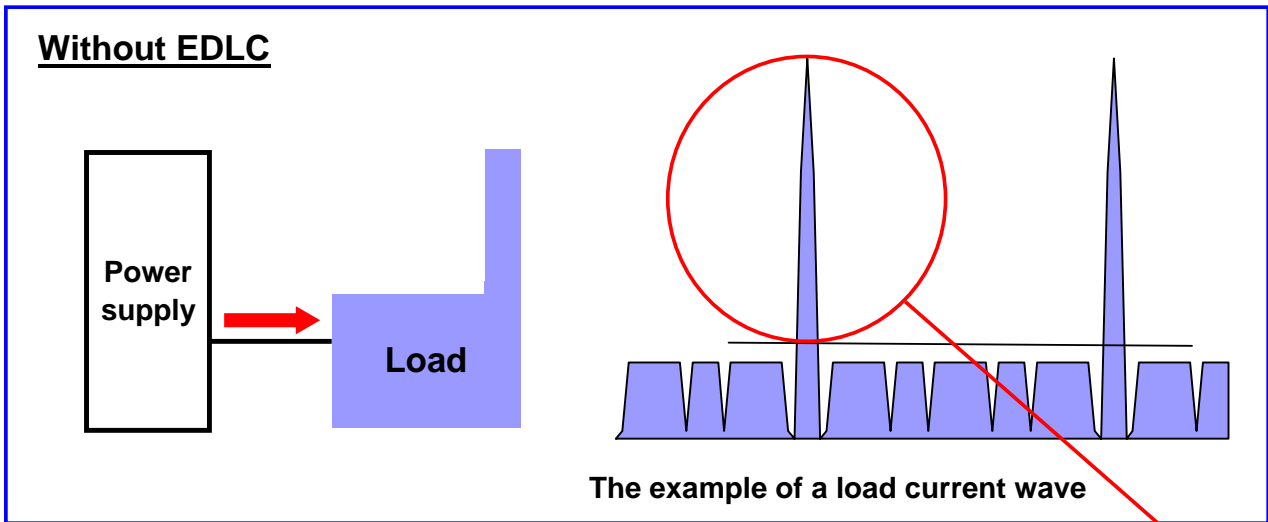

Equivalent

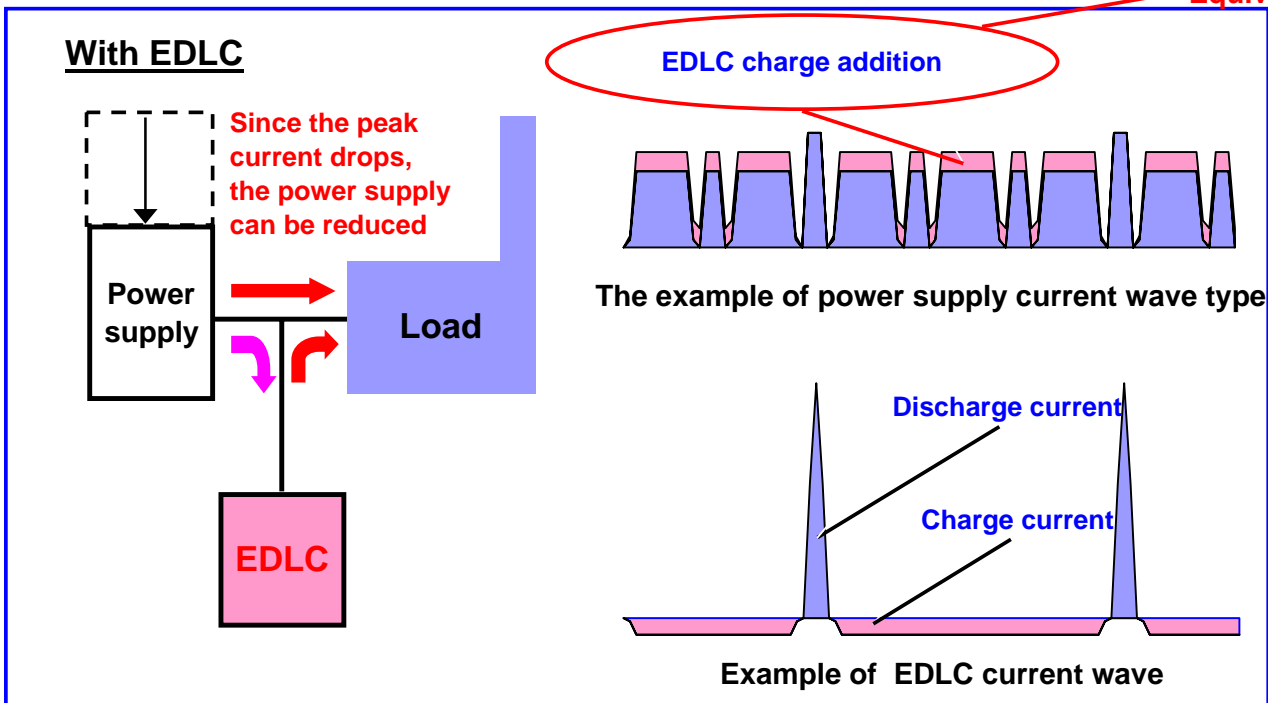

### Application Examples:

- Battery load reduction (DSC, transmitter dispatch assistance, HD audio etc.)
- Electric toy
- USB bus power assistance
- Copy machine drum pre-heating

*It charges quickly and discharges slowly (uniformly).*

## 2. Equalization of output electric power.

An Electric Double Layer Capacitor (EDLC) has extraordinarily higher capacitance compared to a common capacitor also to float charge and fault electric discharge from a battery, it is the the best for absorption of change and equalization of the big electric power in a big span .

### Conceptual diagram

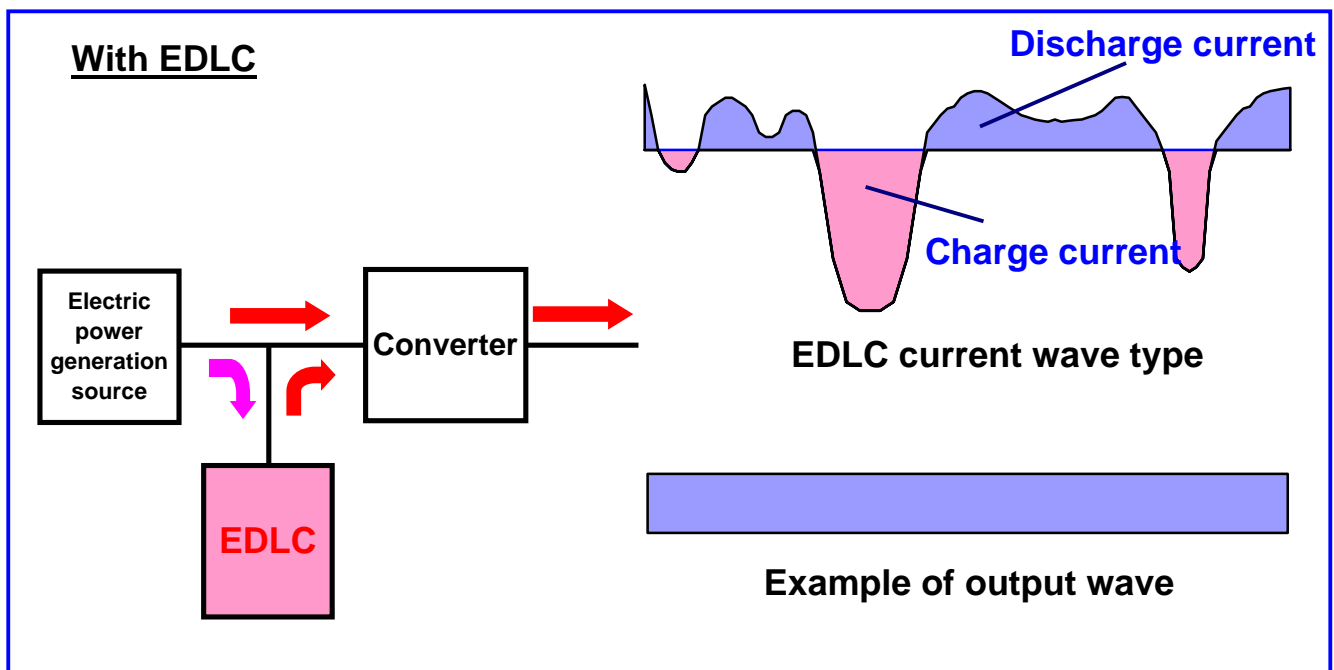
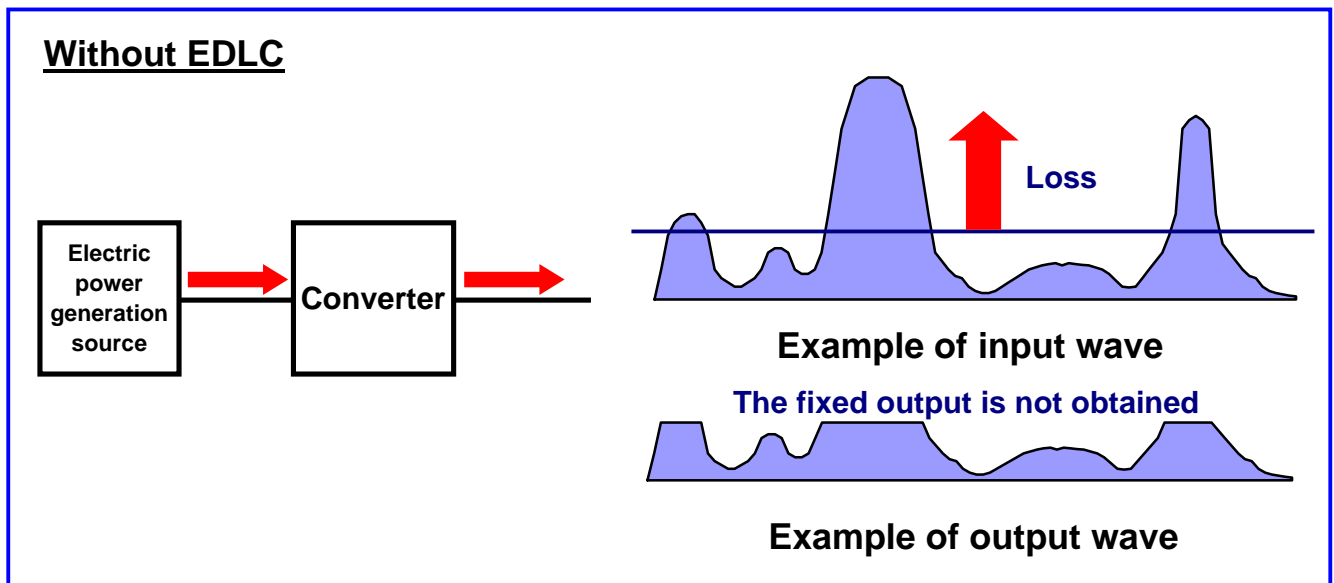

### Application Example:

- Wind power change absorption

*It charges quickly and discharges slowly (uniformly).*

## 2. Equalization of output electric power.

An Electric Double Layer Capacitor (EDLC) has extraordinarily higher capacitance compared to a common capacitor also to float charge and fault electric discharge from a battery, it is the the best for absorption of change and equalization of the big electric power in a big span .

### Conceptual diagram

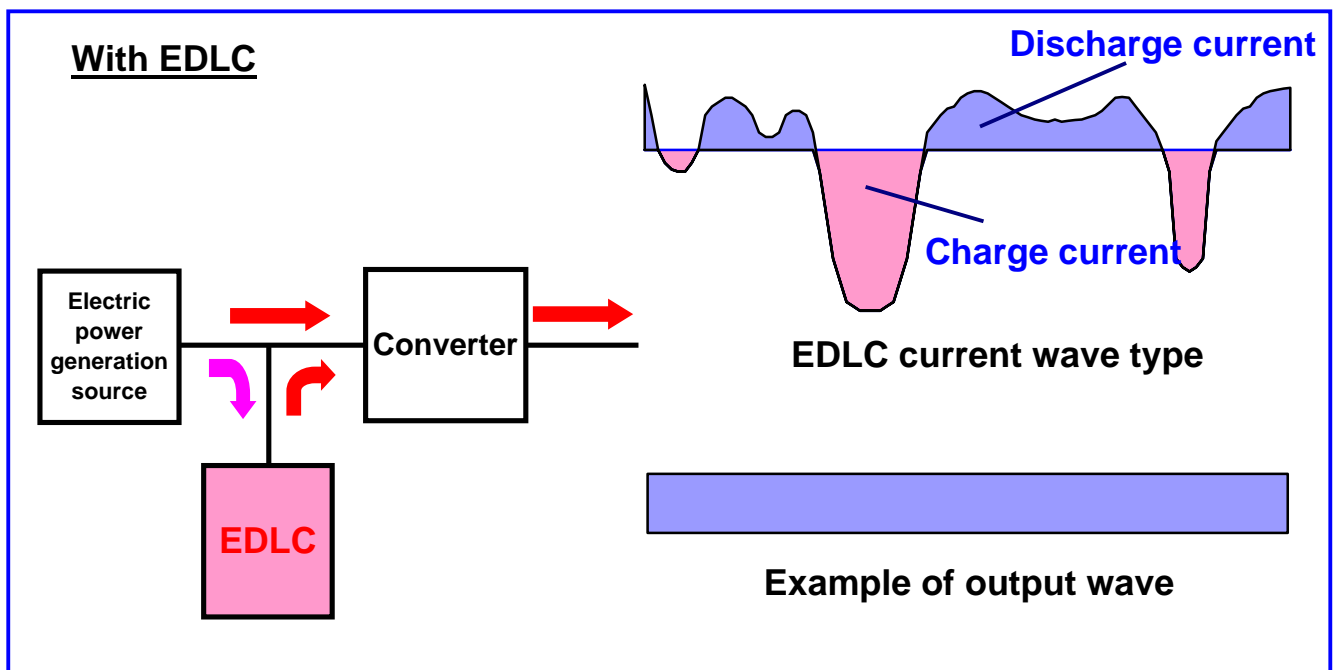
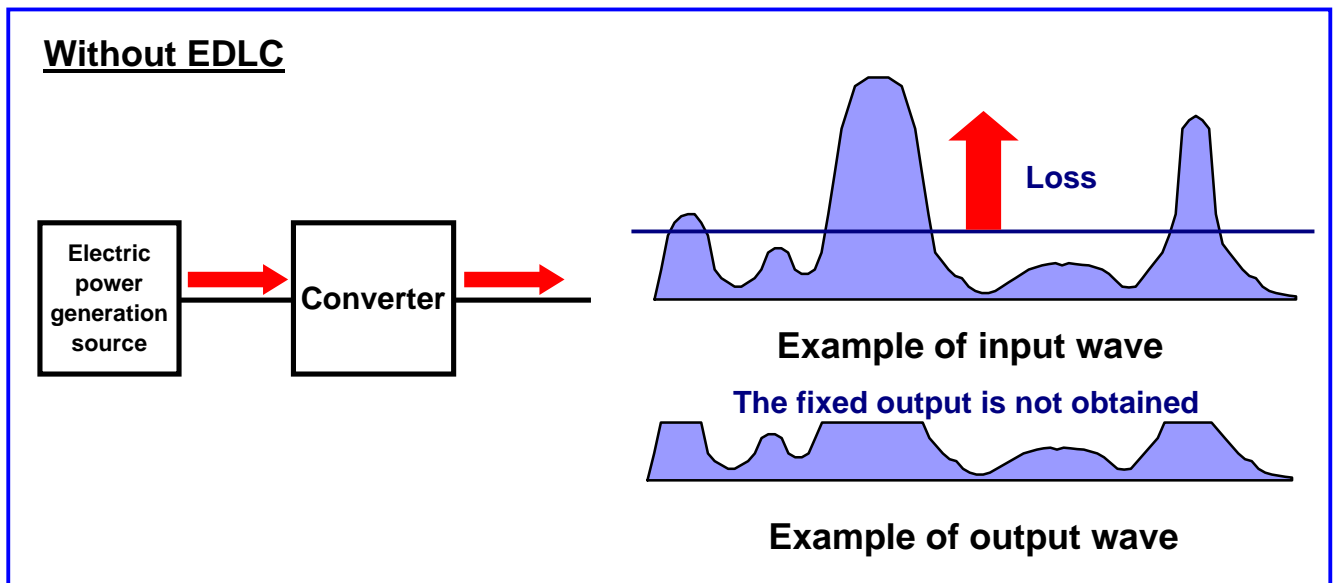

### Application Example:

- Wind power change absorption

*It charges quickly and discharges quickly.*

### 3. Regeneration of wasted electric power.

In an application in which a round trip, up-and-down motion, or start-stop is repeated, the energy generated at the time of the opposite direction of work is typically wasted. If the energy can be recovered, it is possible to use that energy as a supplement power source for the forward direction operation. In order to recover efficiently, the Electric Double Layer Capacitor (EDLC), which can be rapidly charged & discharged due to its low internal resistance.

#### Conceptual diagram

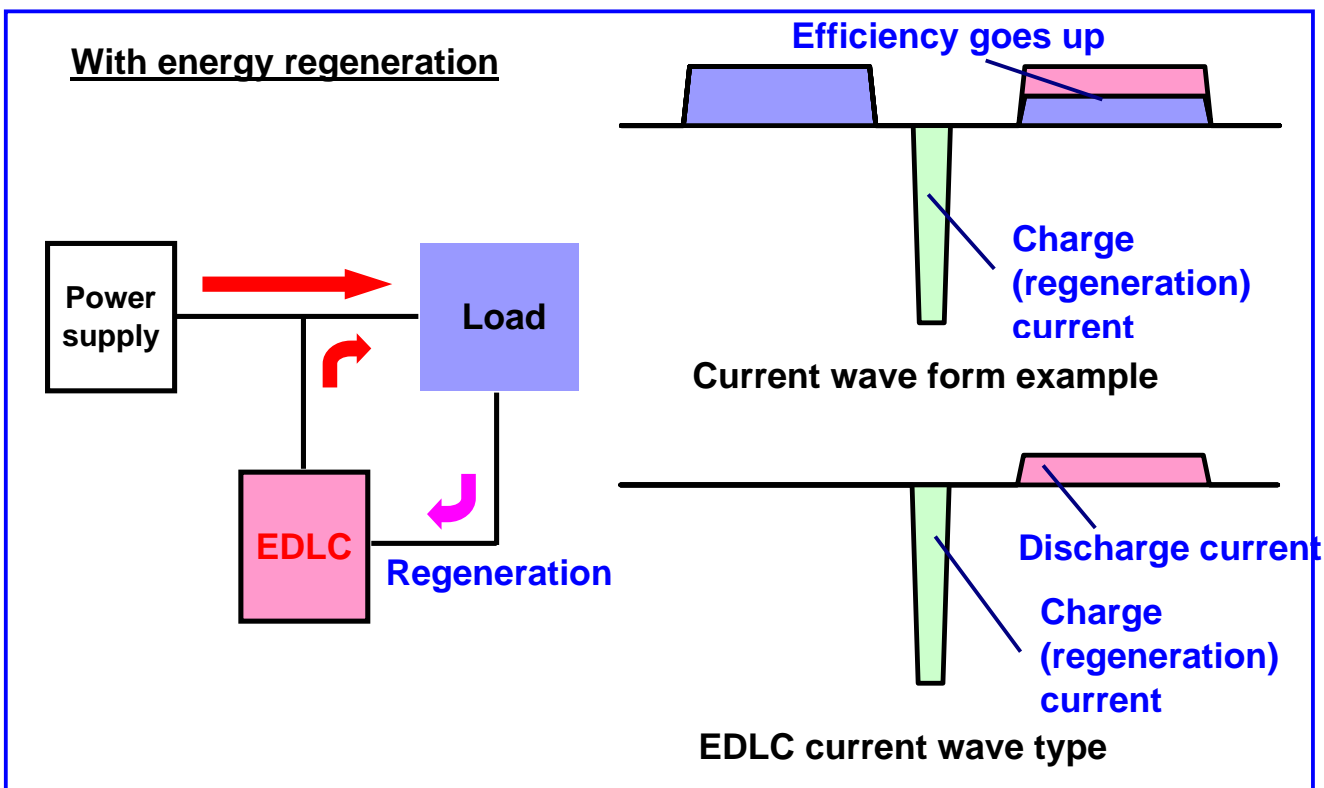
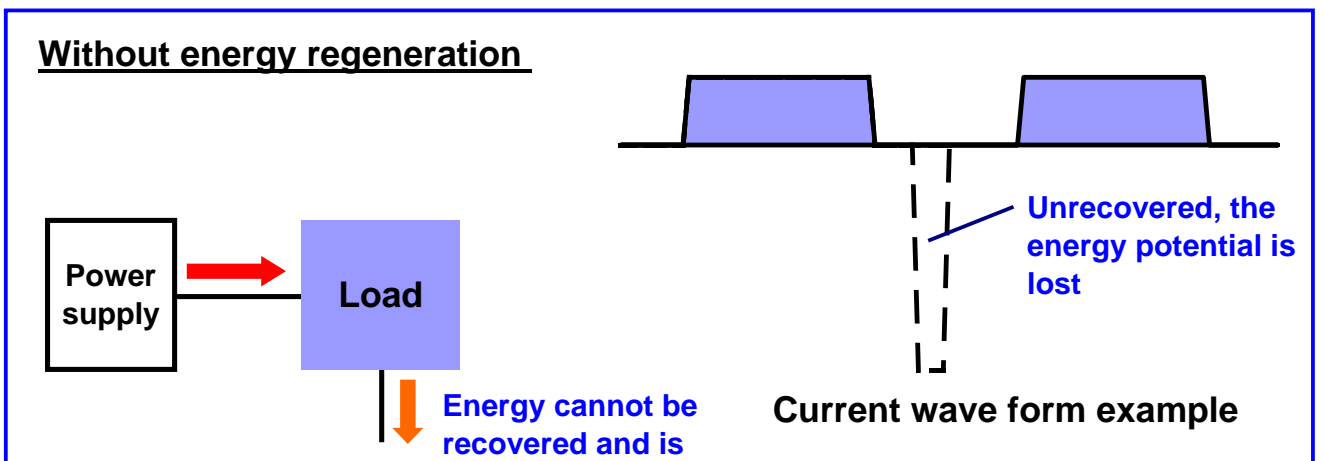

#### Application Examples:

- Elevator
- Heavy Duty Construction & Farm Equipmer
- Railroad Vehicles

*It is maintenance-free and highly reliable.*

**4. A reliable power supply for emergencies.**

Generally, an Electric Double Layer Capacitor (EDLC) has the following advantages as compared to a battery (in addition to low internal resistance):

- a. Unlimited charge and discharge cycles.
- b. Wide operating temperature range.
- c. Low capacitance loss over life of product.
- d. Even with a decline in capacitance, the EDLC will be usable to max voltage.

An EDLC is ideal as a source of backup power with long-term reliability.

**Application Examples:**

- Uninterruptable Power Supply (UPS)
- Emergency actuator drive (power failure)
- Circuit operation in case of power failure (IC, a memory card drive, HD drive,
- LED drive (Combination with a solar battery)
- Memory backup of real-time clock (RTC) etc.

*User interaction is not required.*

**5. Discharge time required is pre-set.**

If voltage output declines, in a linear method, an Electric Double Layer Capacitor (EDLC) can be used to set the operational time by choosing a specific capacitance value. Essentially the EDLC becomes a power supply, without the need for a

Discharge time, voltage, and capacitance is shown in the following formulas:

For constant current  
discharge:

$$t = C \times (V_0 - V_1) / I$$

For constant resistance  
(load) discharge:

$$t = - C \times R \times \ln (V_1 / V_0)$$

t :Discharge time

C :Capacitance

I :Discharge current

R :Load resistance

V<sub>0</sub> :Charge voltage

V<sub>1</sub> :After discharge voltage

**Application Examples:**

- Electric toy
- PC Projector cooling fan