

Systematized Classification of Aluminum Electrolytic Capacitors

Conductive Polymer Hybrid Aluminum Electrolytic Capacitors

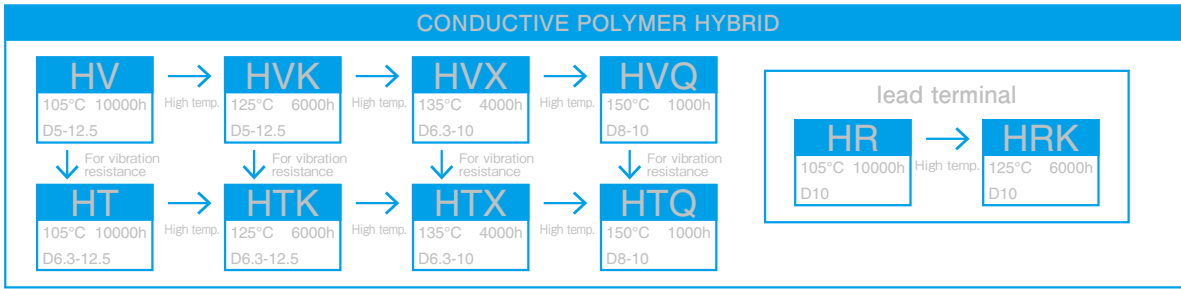

Aluminum Electrolytic Capacitors with Conductive Polymer Solid Electrolyte

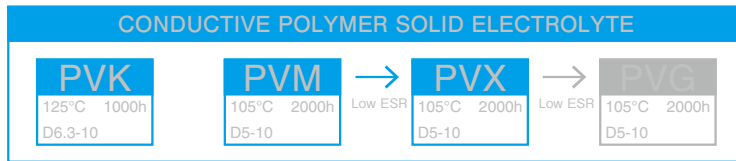

Chip Type Aluminum Electrolytic Capacitors

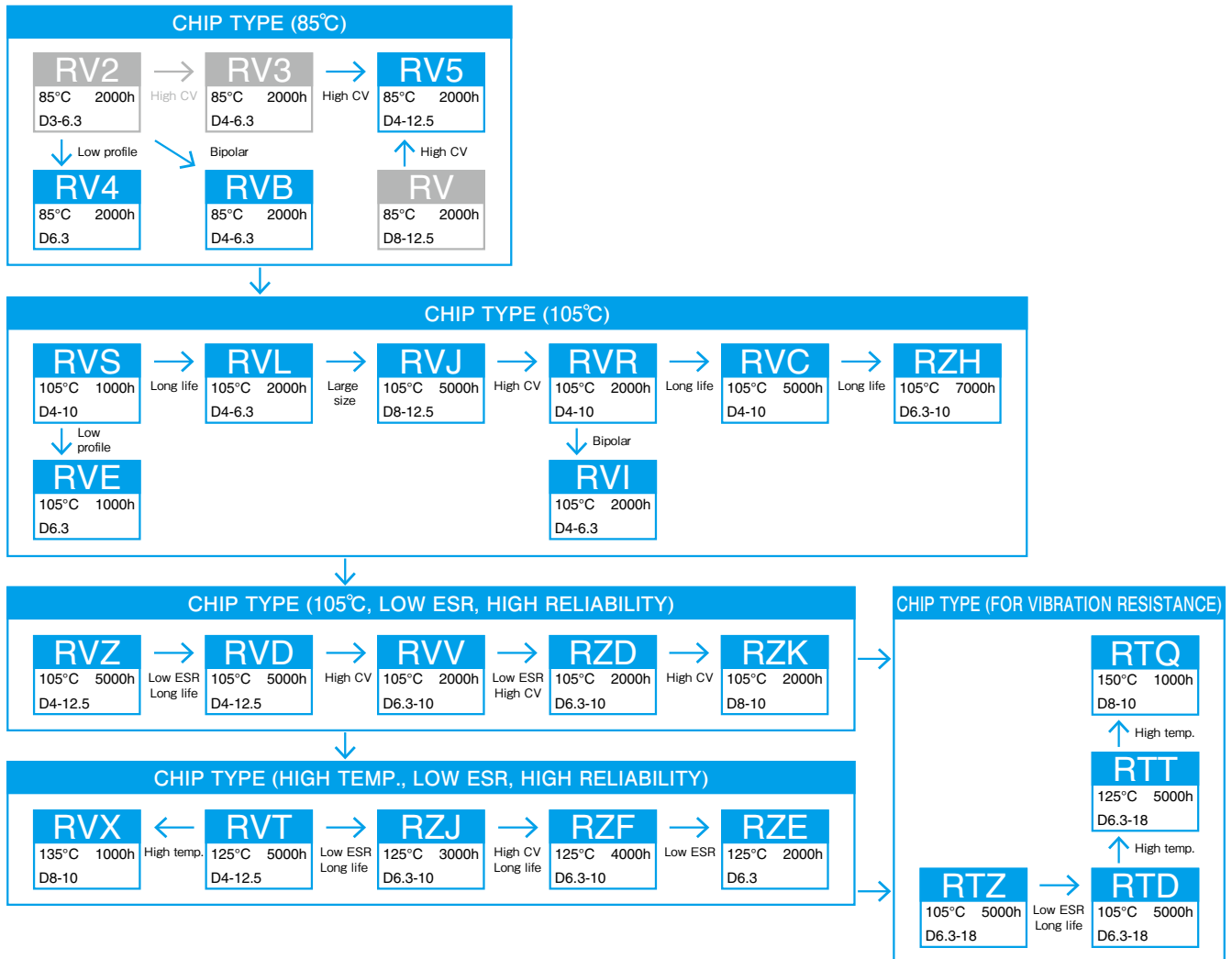

NOTE : Design, Specifications are subject to change without notice.  
It is recommended that you shall obtain technical specifications from ELNA to ensure that the component is suitable for your use.

■ Systematized Classification of Aluminum Electrolytic Capacitors

● Miniature Aluminum Electrolytic Capacitors

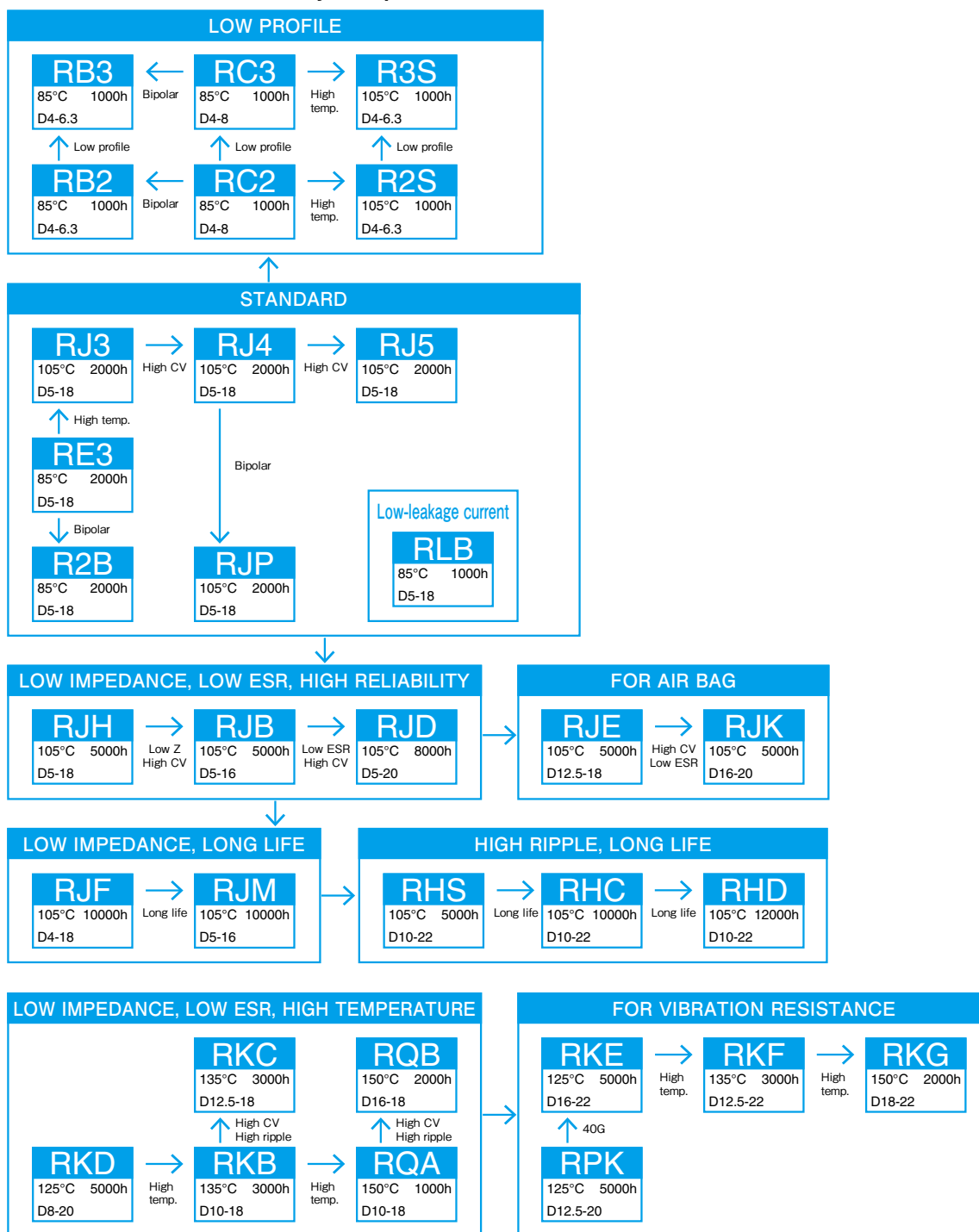

NOTE : Design, Specifications are subject to change without notice.  
It is recommended that you shall obtain technical specifications from ELNA to ensure that the component is suitable for your use.

■ Systematized Classification of Aluminum Electrolytic Capacitors

● Large Capacitance Aluminum Electrolytic Capacitors

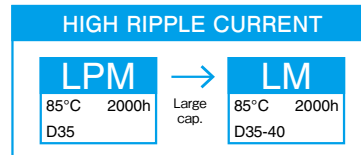
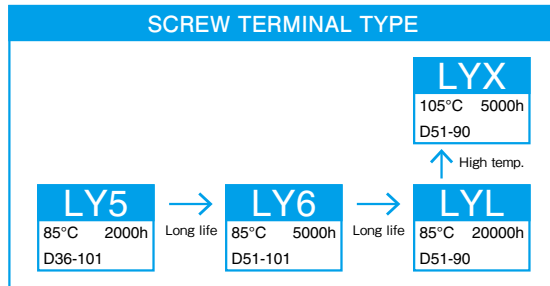
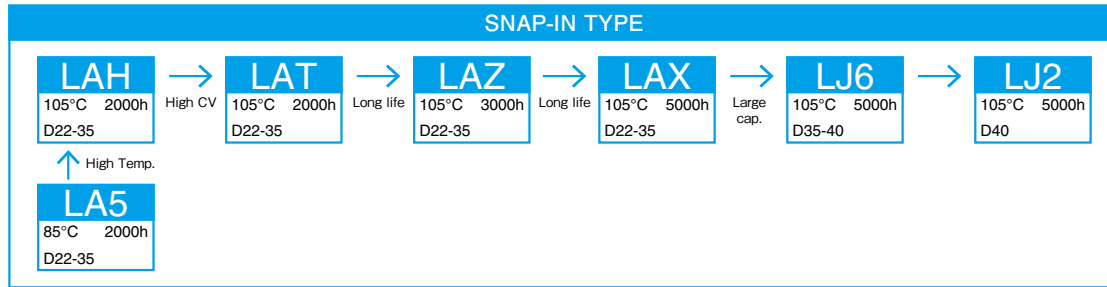

● Aluminum Electrolytic Capacitors For Audio

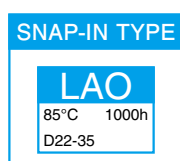
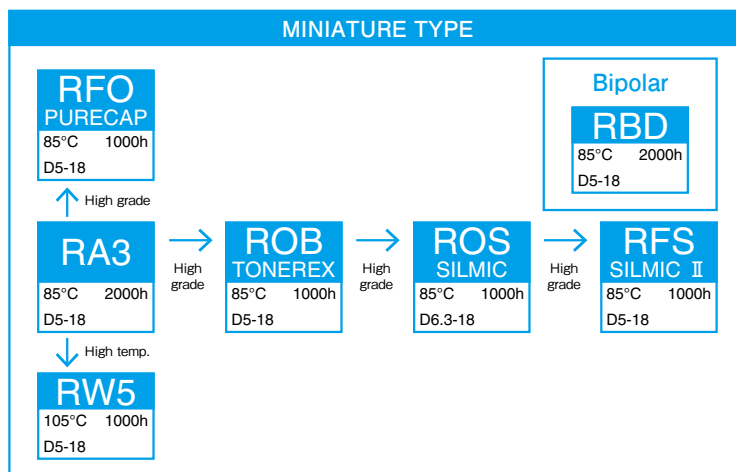
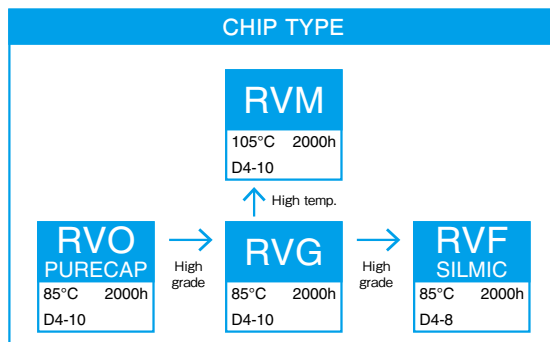

NOTE : Design, Specifications are subject to change without notice.  
It is recommended that you shall obtain technical specifications from ELNA to ensure that the component is suitable for your use.